

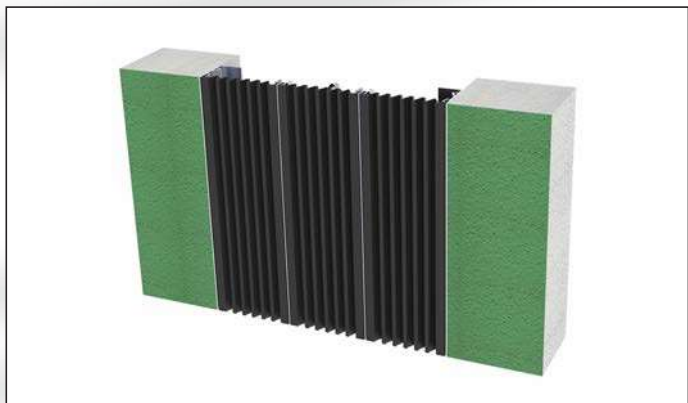

Profilés de Mur & Plafond

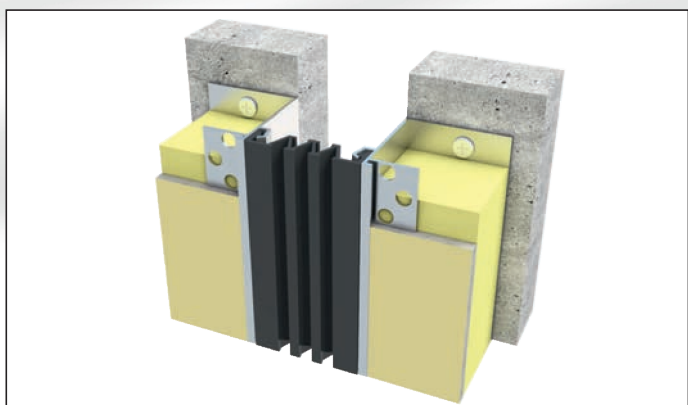

AS A119 300 H50

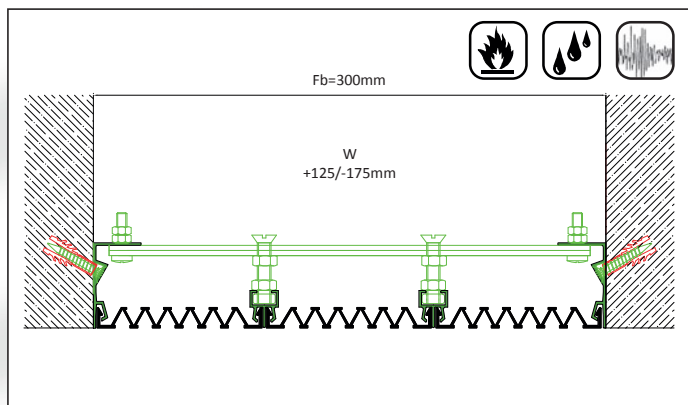

AS A124 050 H47/57

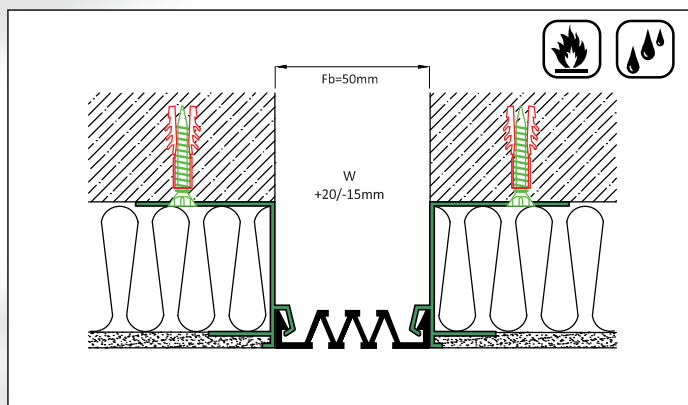

AS A150 100 H26

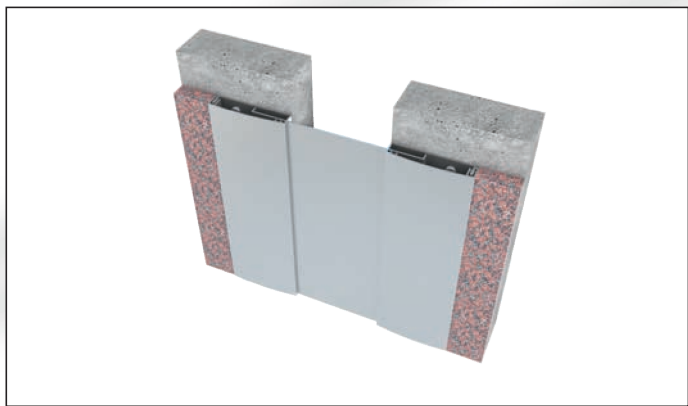
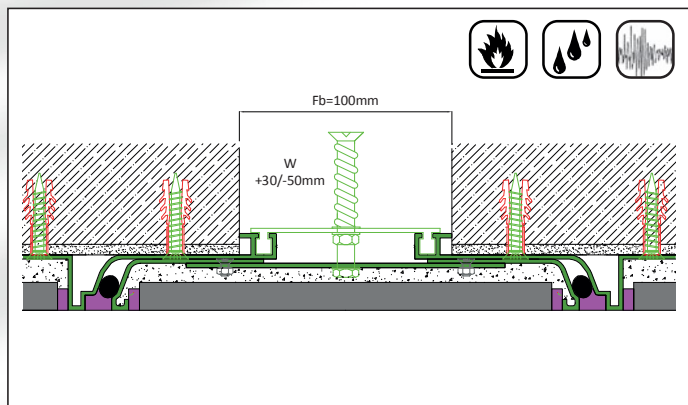

AS A155 100 H16

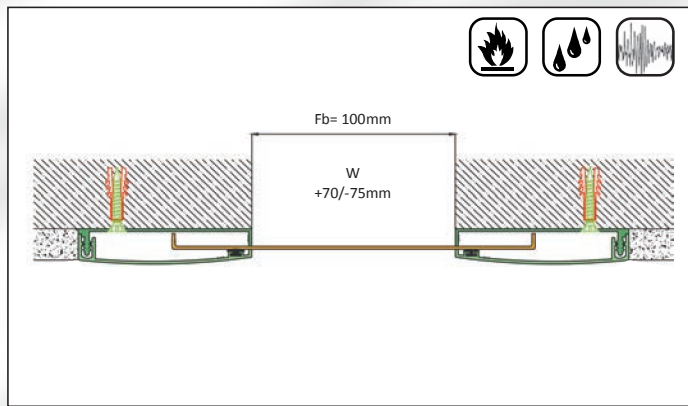

* Nous consulter pour préconisation pour angles et différentes ouvertures (Fb).

* Veuillez demander notre catalogue principal pour nos solutions avec différents modèles.

Profilsés de Sol Montés en Surface

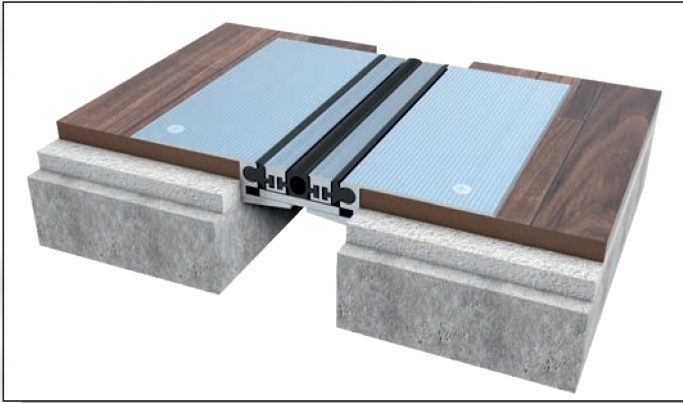

AS U236 060 H23

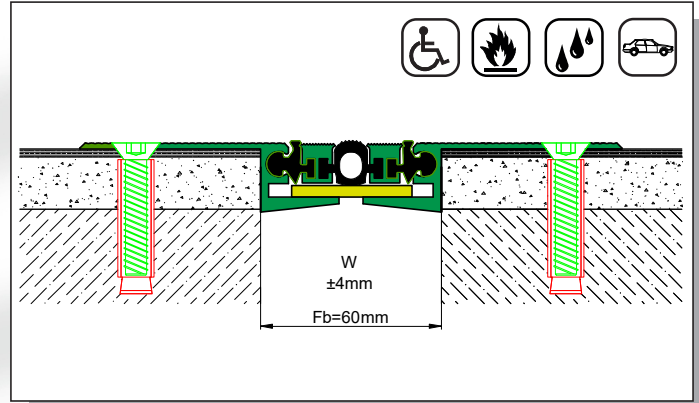

AS U243 050 H27

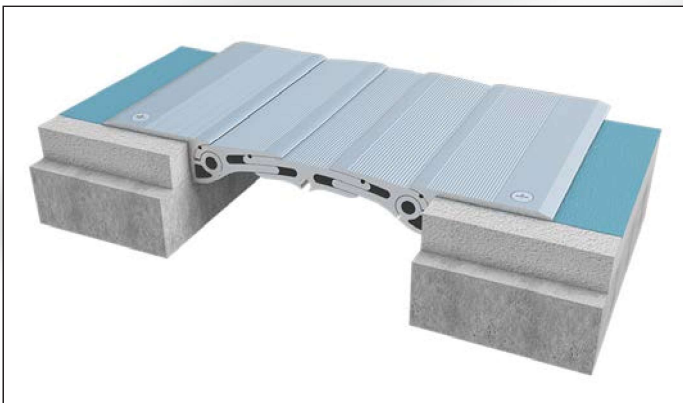
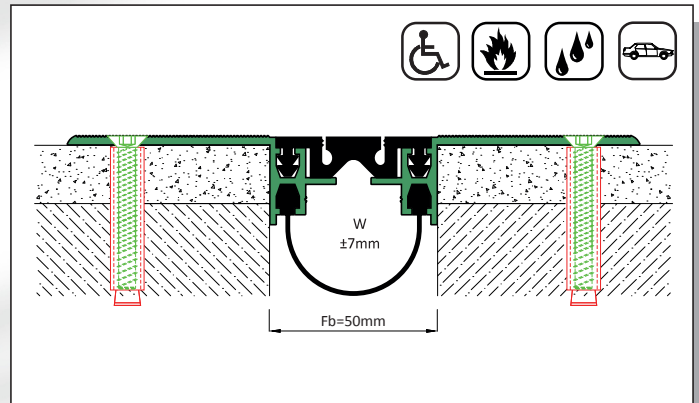

AS U264 150 H30

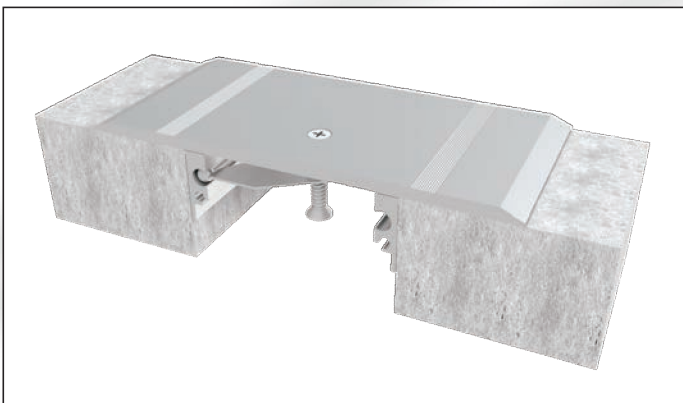
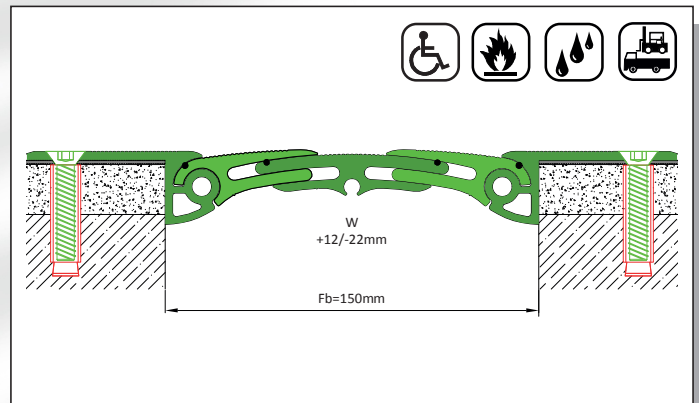

AS U281 100 H35

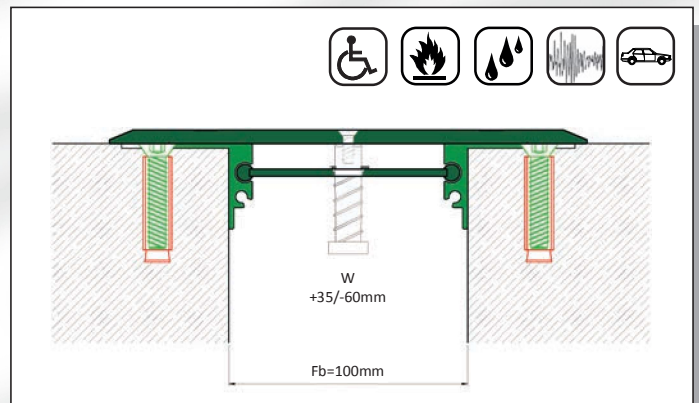

* Nous consulter pour préconisation pour angles et différentes ouvertures (Fb).

* Veuillez demander notre catalogue principal pour nos solutions avec différents modèles.

Profilsés de Sol Encastrés

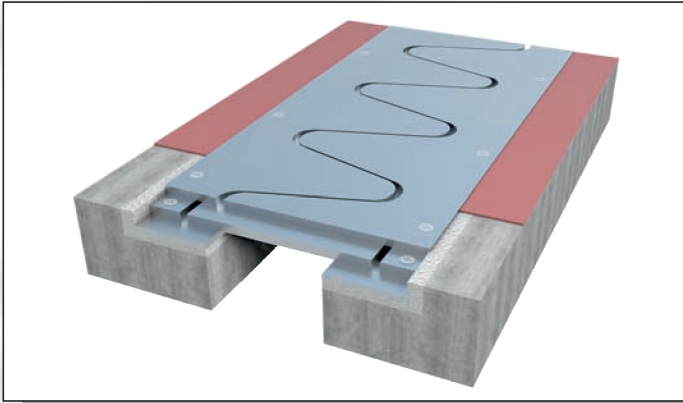

AS A270 100 H24

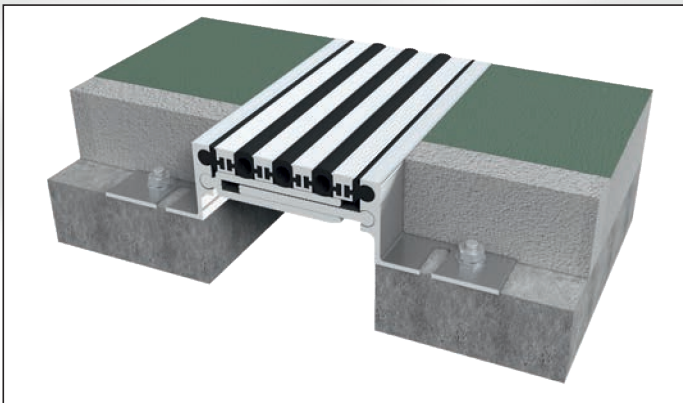
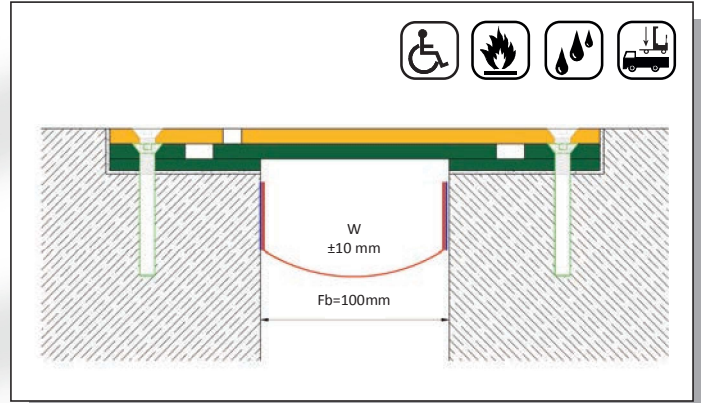

AS A226T 100 H43

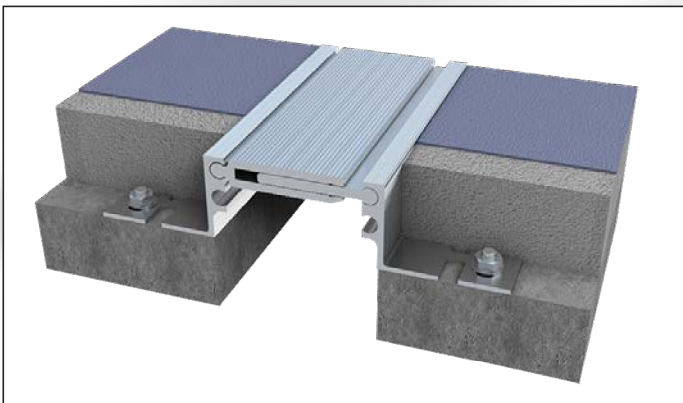
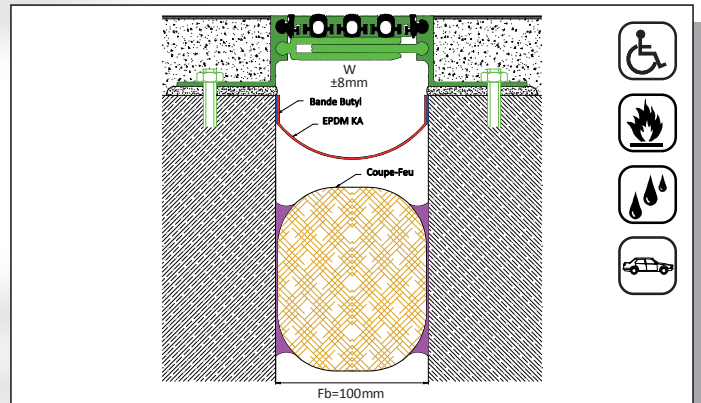

AS A227T 080 H43

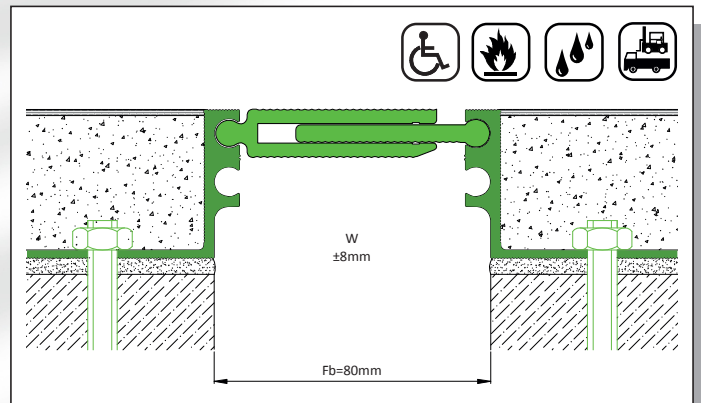

AS A246 100 H45

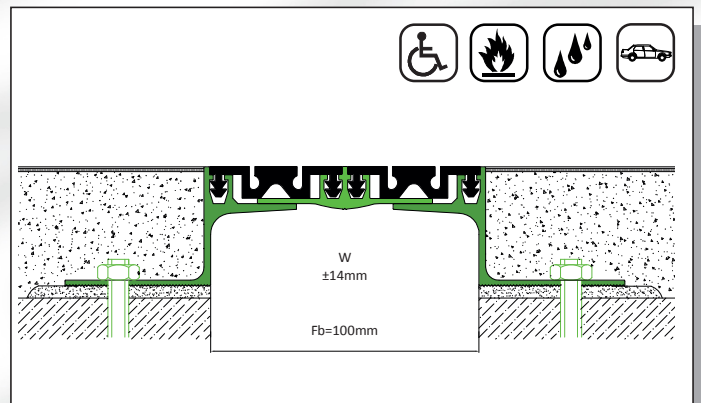

* Nous consulter pour préconisation pour angles et différentes ouvertures (Fb).

* Veuillez demander notre catalogue principal pour nos solutions avec différents modèles.

Profilsés de Sol Encastrés

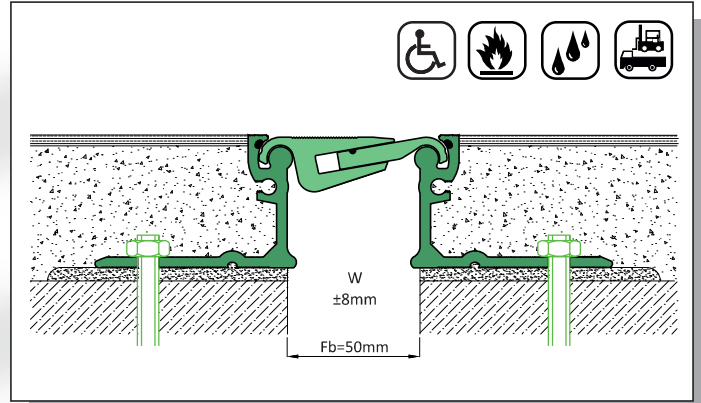
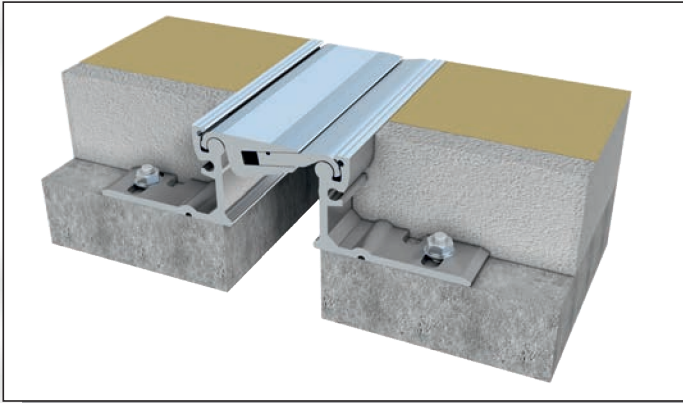

AS A225 050 H50

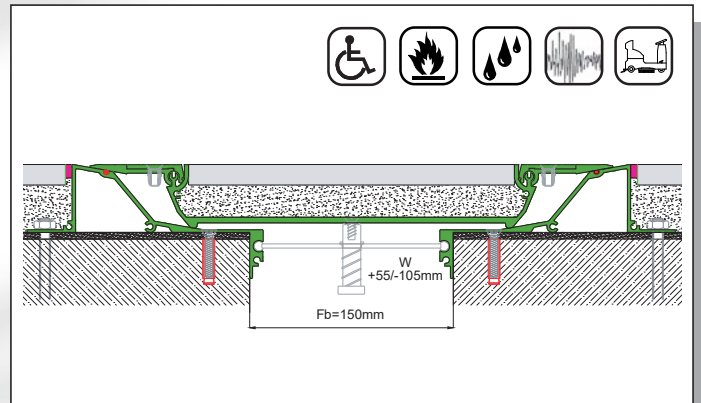

AS A239 150 H50

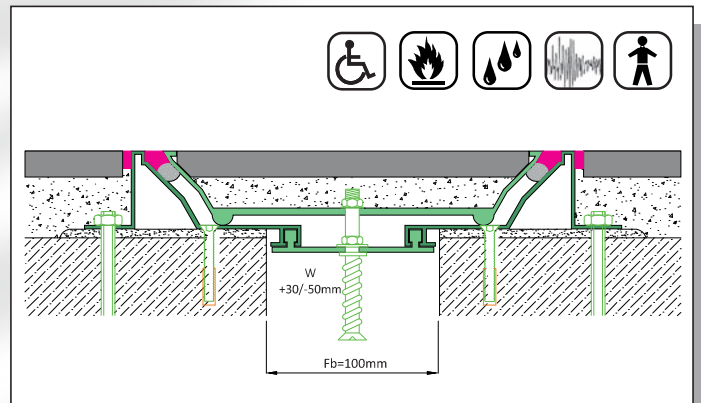
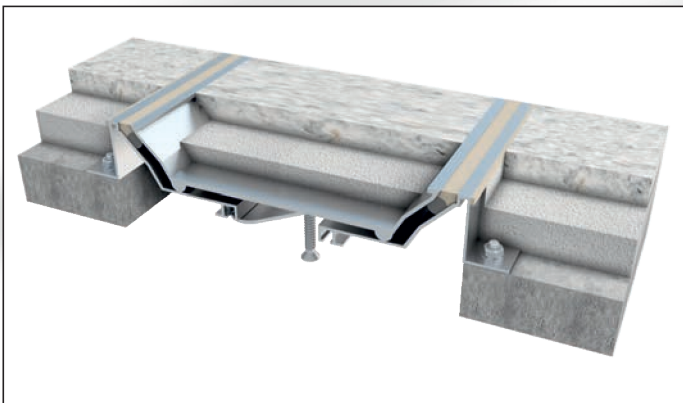

AS A250 100 H45

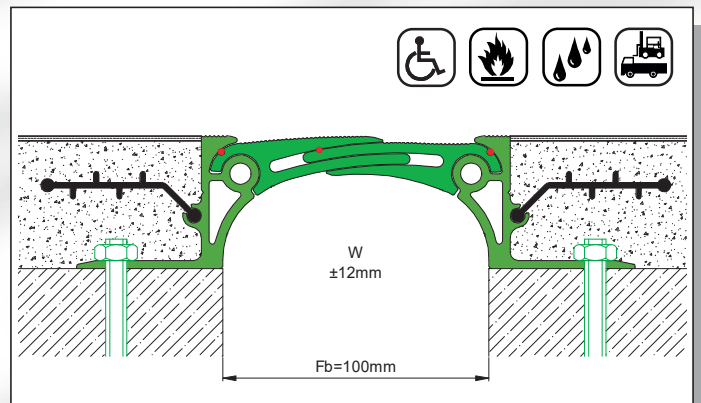
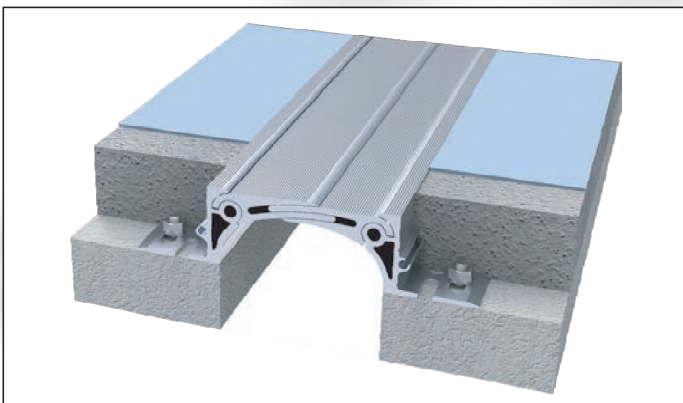

AS A263 100 H50

* Nous consulter pour préconisation pour angles et différentes ouvertures (Fb).

* Veuillez demander notre catalogue principal pour nos solutions avec différents modèles.

Profilsés de Sol Etanche

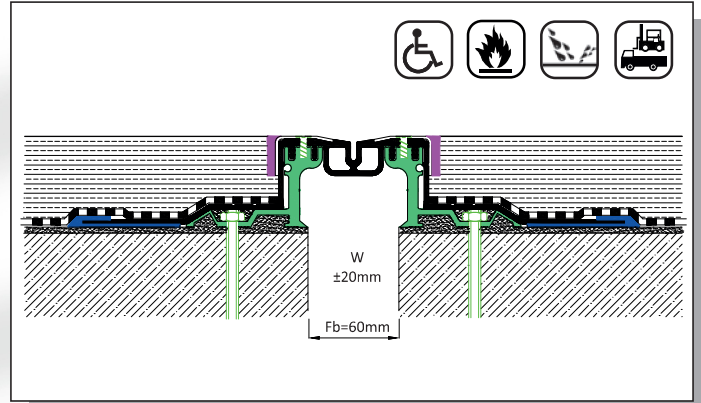
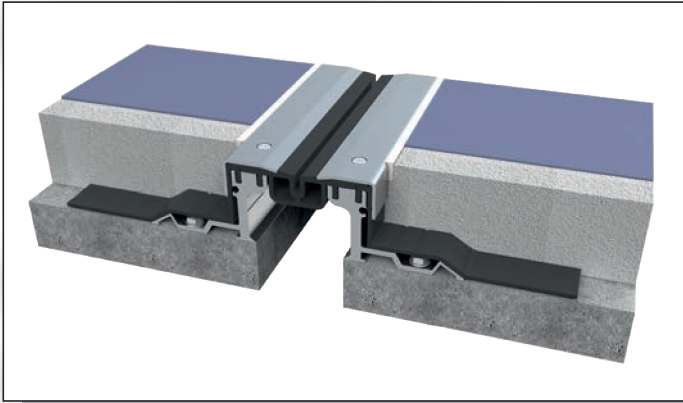

AS A290 060W1 H60

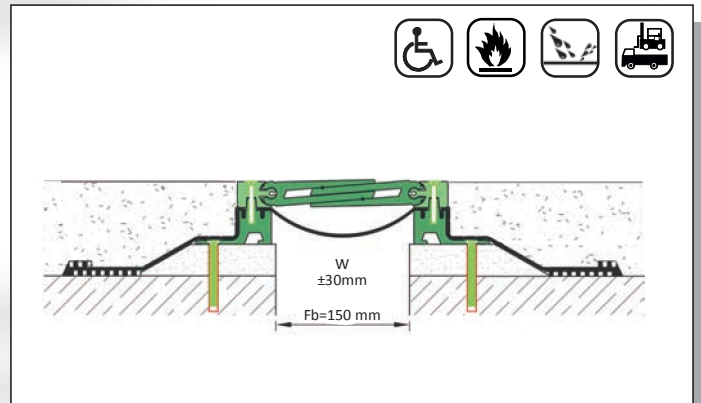

AS A295 150 H70

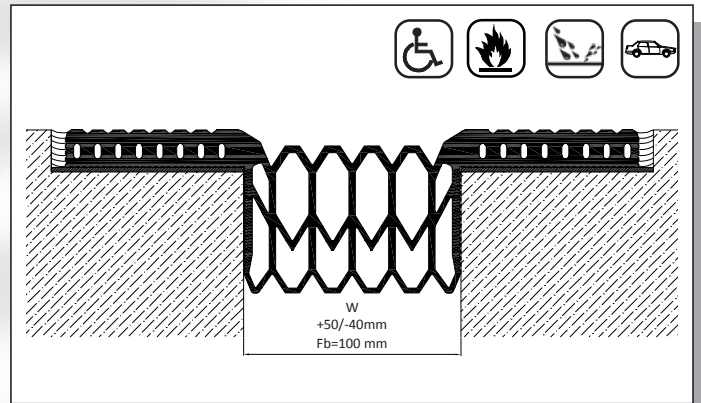
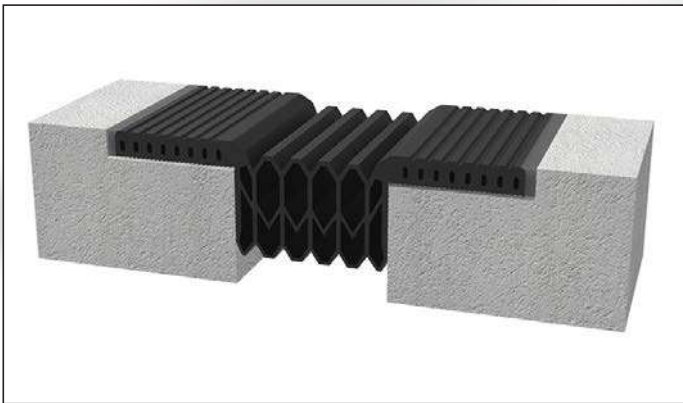

AS A293 100 H17

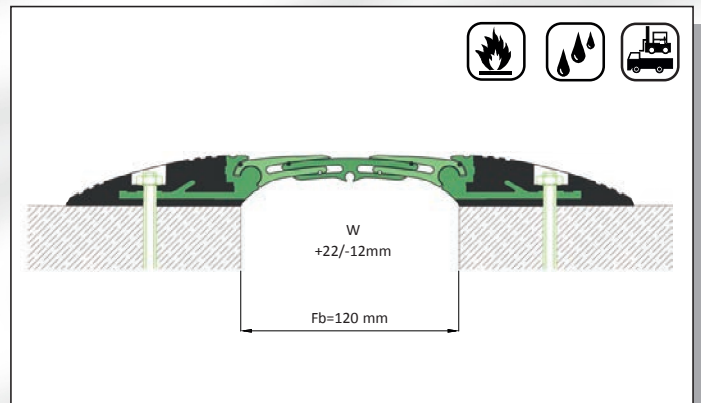
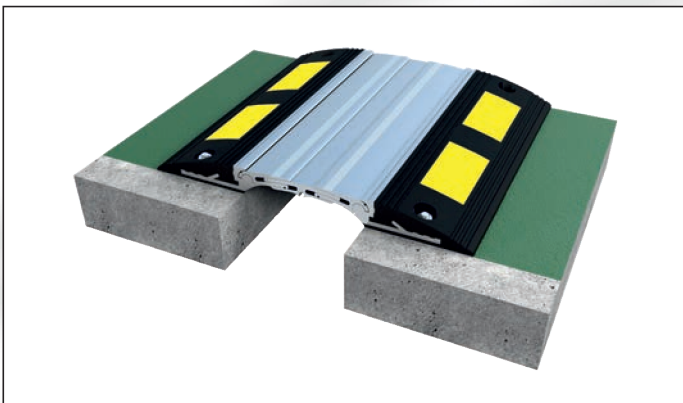

AS U274 120 H35

* Nous consulter pour préconisation pour angles et différentes ouvertures (Fb).

* Veuillez demander notre catalogue principal pour nos solutions avec différents modèles.

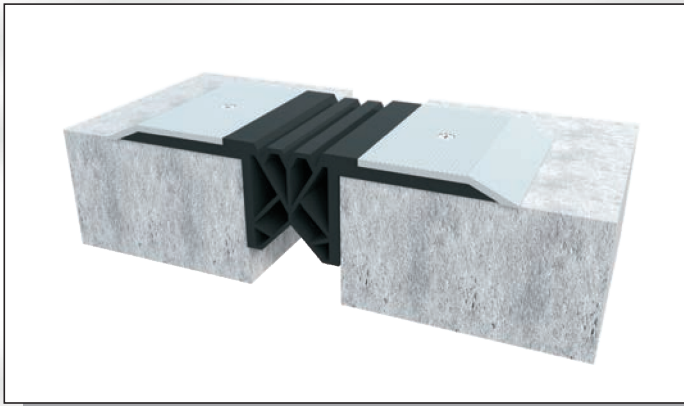

AS U294 080 H11

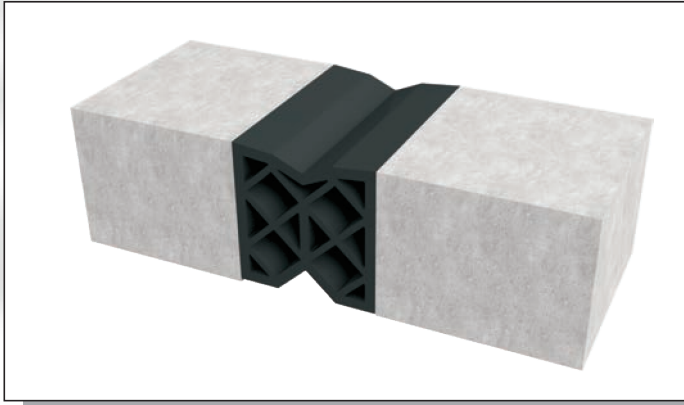
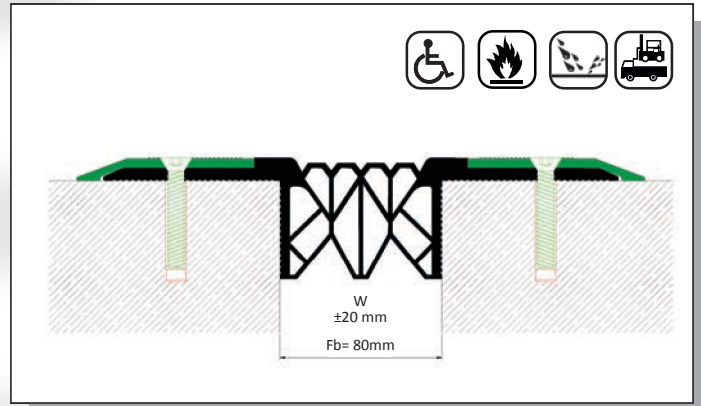

AS U242 107-90

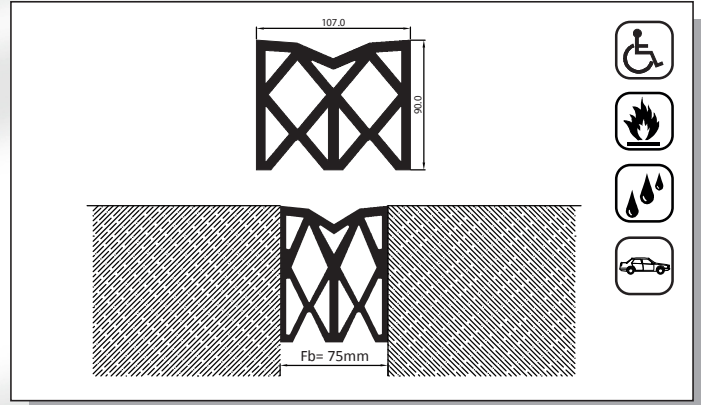

Couvre Joints de Toiture et de Parapet



AS SHP 100

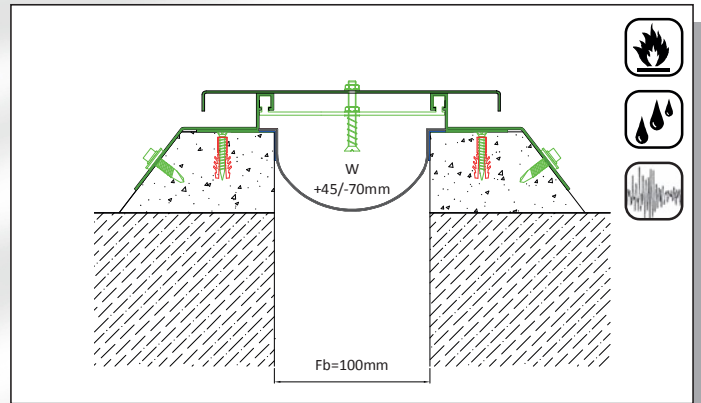

AS UPP 330080

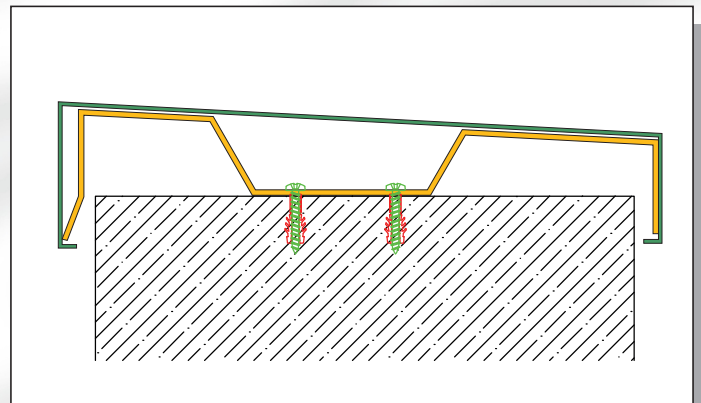

* Nous consulter pour préconisation pour angles et différentes ouvertures (Fb).

* Veuillez demander notre catalogue principal pour nos solutions avec différents modèles.

Couvre Joints de Sol Anodisés

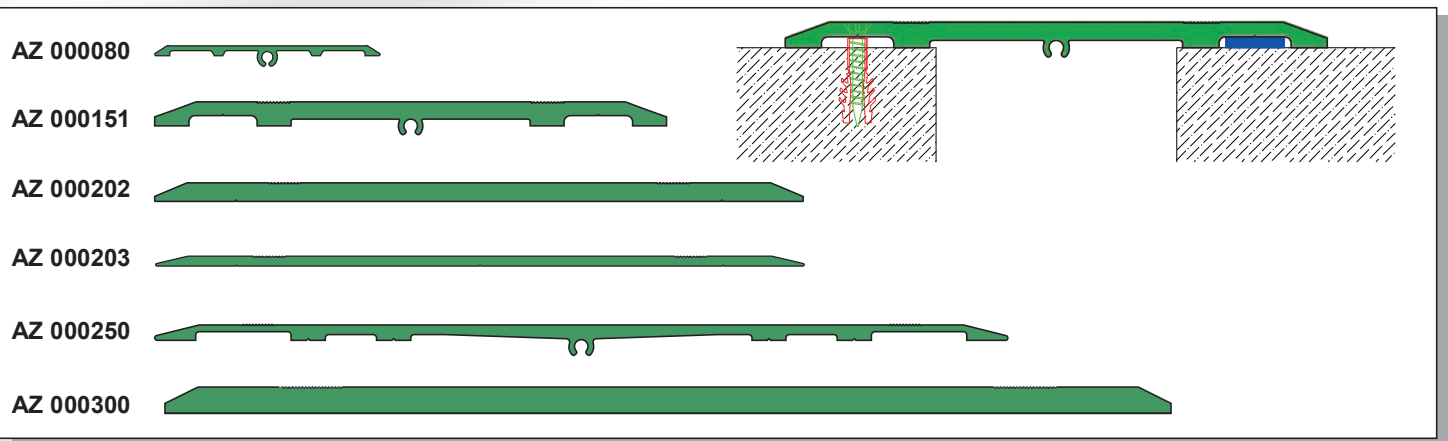

Couvre Joints de Mur & Plafond Anodisés

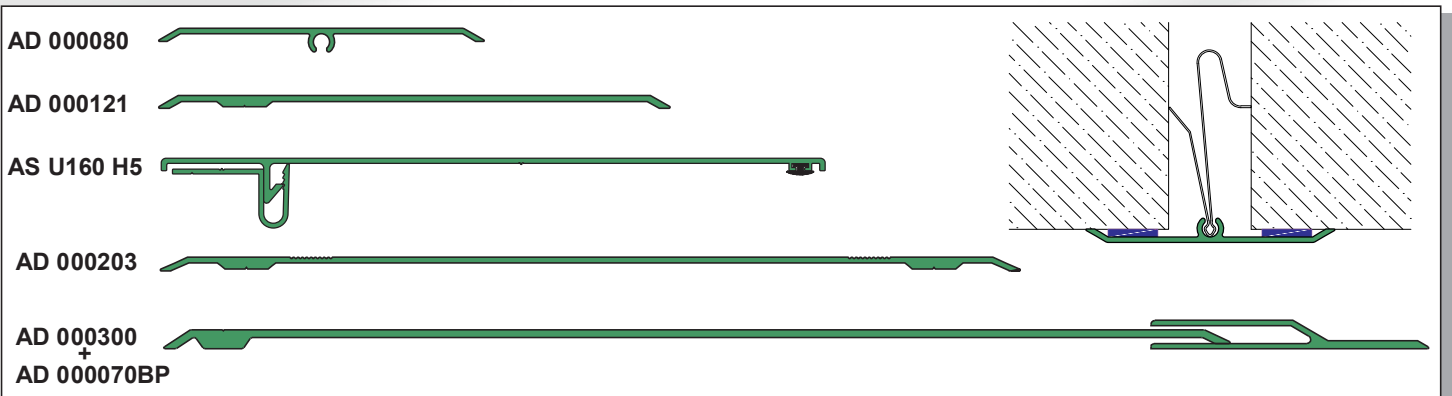

Couvre Joints d'Angle Anodisés

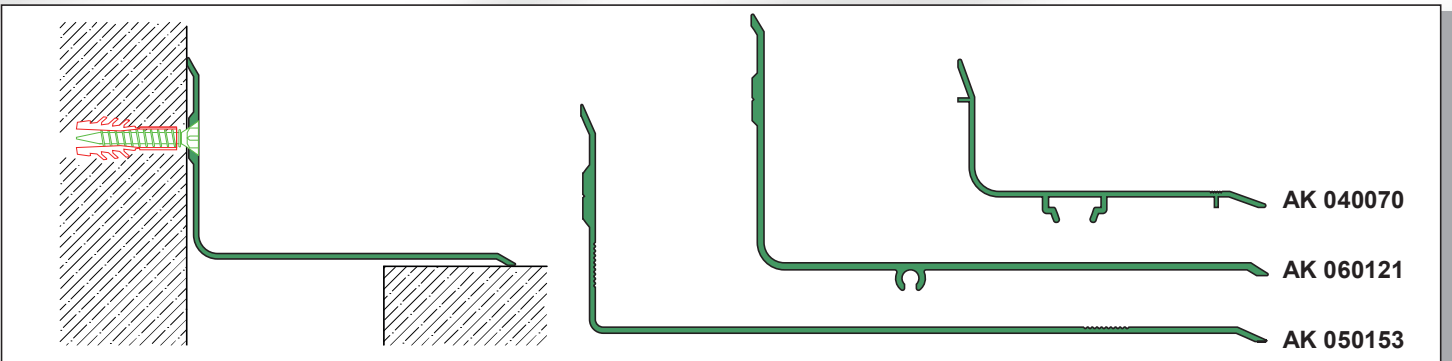

Pinces à ressort en acier

AY 5045 C00
Fb=20-30mm

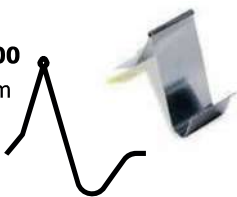

AY 5545 C00
Fb=35-50mm

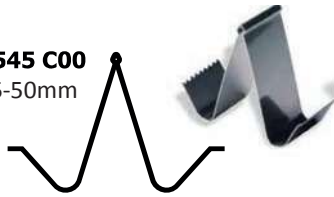

AY 1065 C00
Fb=55-90mm



* Nous consulter pour préconisation pour angles et différentes ouvertures (Fb).

* Veuillez demander notre catalogue principal pour nos solutions avec différents modèles.



Pour plus d'informations:
www.asprodesign.com
info@asprodesign.com

Siège: Esenkent Mah. Buyruk Sokak No:15/A 34776
Ümraniye -İstanbul
Tel: +90 216 466 72 63 Faks: +90 216 466 72 64